

WINDOW CLEANING



Experience
the new
Moerman
window
cleaning tools

These tools are all about durability, design, performance, ergonomics and quality materials.

WINDOW CLEANING

NEW



COMBINATOR HANDLE
Pg 26



PREMIUM HANDLE (BI-COMPONENT)
Pg 29



SWIVEL SQUEEGEE HANDLE
Pg 28



STAINLESS STEEL HANDLE
Pg 28

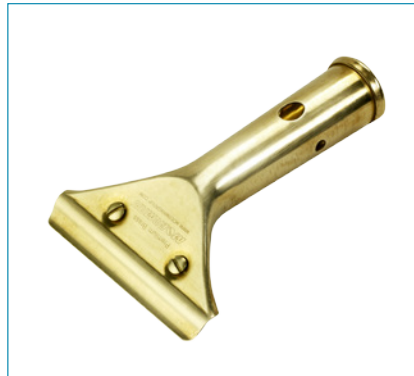

BRASS HANDLE
Pg 29

UNIQUE



LIQUIDATOR CHANNELS & RUBBER
Pg 27



STAINLESS STEEL CHANNELS
Pg 30



ALUMINIUM CHANNELS
Pg 30



BRASS CHANNELS
Pg 30

WINDOW CLEANING



DURA-FLEX® RUBBER
Pg 31



WEB DUSTER
Pg 40



PIPE DUSTER
Pg 40



PREMIUM SCRAPER
Pg 38



PREMIUM SCRAPER WITH HANDLE
Pg 38



SCRAPERS
Pg 39



REPLACEMENT BLADES
Pg 39



WINDOW CLEANING



PREMIUM T-BAR (BI-COMPONENT)
Pg 32



SWIVEL T-BAR
Pg 32



MONO T-BAR
Pg 33



COMBINATOR
Pg 26



EXTENSION POLES
ANGLE ADAPTER
Pg 36



PREMIUM SLEEVE
Pg 35



SILVER SLEEVE
Pg 35



SCRUBBING PAD SLEEVE
Pg 35



STANDARD SLEEVE
Pg 35

WINDOW CLEANING



TOOL HOLDER & BELT
Pg 37



PROFI POUCH
Pg 37



CLICK & SCRUB PAD
Pg 33



BUCKETS & ACCESSORIES
Pg 41



GLOVES
Pg 37



DETAILING CLOTH
Pg 41



CHAMMY
Pg 41



COMBINATOR



TAKE IT TO THE NEXT LEVEL!



WATCH THE VIDEO

REDUCED DETAILING

TIME SAVING



EFFICIENCY

- Reducing cloth prepping
- Don't lose time changing tools

AMAZING RESULTS!!

- Amazing results with less effort
- No water residues in corners & edges

SAFE

- No need to reach out with a cloth
- Reliable locking and click-on parts

ERGONOMICS

- Lightweight for easy handling
- Light pressure channel

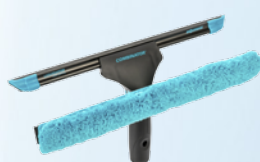

wash - flip - wipe



one pass



wipe only

WIPE ONLY

Combinator handle + thumb rest insert + Liquidator channel + rubber

COMBINATOR SET

Combinator handle + Liquidator channel + rubber + Thumb rest insert + Combinator premium sleeve + Combinator T-bar

	25 cm/10"	35 cm/14"	45 cm/18"	
Combinator handle	22553	22553	22553	10 pcs/box
Combinator T-bar	22554	22555	22556	10 pcs/box
Combinator Premium sleeve	22559	22560	22561	10 pcs/box
Liquidator channel + rubber	21978	21979	21980	20 pcs/box

LIQUIDATOR

TAKE IT TO THE NEXT LEVEL!



WATCH THE VIDEO

REDUCED DETAILING

UP TO 25% TIME SAVING

EFFICIENCY

- Dura-Flex® rubber is supported all the way until the plastic tips
- Reduces cloth prepping and detailing significantly
- UP TO 25% TIME SAVING

AMAZING RESULTS!!

- Amazing results with less effort
- No water residues in corners & edges

SAFE

- No need to reach out with a cloth (eg on a ladder)
- Plastic tips = no damage to window frames thanks to the high grade moulded plastic tips

ERGONOMICS

- Lightweight aluminum channel for easy and precise handling
- Light pressure channel for increased speed and performance



Ideal in combination with premium, swivel of combinator handle

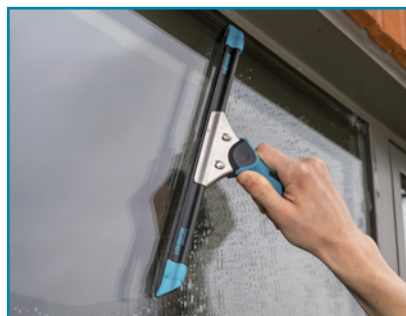

Liquidator channel + Liquidator Dura-Flex® rubber soft



25 cm/10"	21978
30 cm/12"	22147
35 cm/14"	21979
45 cm/18"	21980
55 cm/22"	22148



Packaging 20 pcs/display box

SWIVEL SQUEEGEE HANDLE

- Fastens securely to locking cone on extension pole. Easy On – Easy Off
- Ergonomic handle
- Pivoting head allows the blade angle to be adjusted to work with odd-shaped windows
- Easy cleaning of hard-to-reach spots

User-friendly: No extra tools needed to turn the head or angle!



Can be put in 2 different angles: 0° and 40° by pushing the button



Easy rubber replacement/channel adjustment

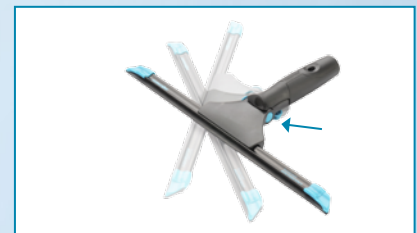

Swivels and blocks in any position by turning the wheel. Better grip to turn the wheel with the improved design

20632 **10 pcs/box**

Use with Liquidator or stainless steel & aluminium channels, sold separately

STAINLESS STEEL HANDLE

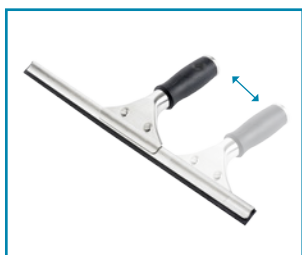

Unique Release Spring
Quick rubber replacement/
channel adjustment

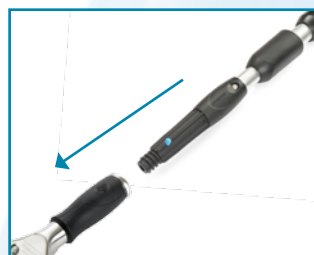

- Fastens securely to locking cone on extension pole.
- Easy On – Easy Off

- Ergonomic handle
- Rubber cover - overmoulded



Premium brushed stainless steel
Rust-resistant

17773 **10 pcs/box**

PREMIUM HANDLE (BI-COMPONENT)



Ergonomic Release Spring
Quick rubber replacement/
channel adjustment

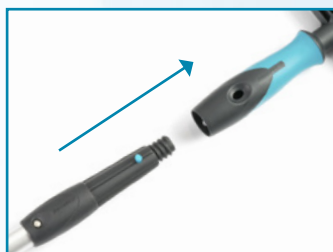

- Fastens securely to locking cone on extension pole.
- Easy On – Easy Off



Premium brushed stainless steel
Rust-resistant

- Anti-slip material
- Soft-touch
- Ergonomic
- Smooth surface
- Secure grip even when wet

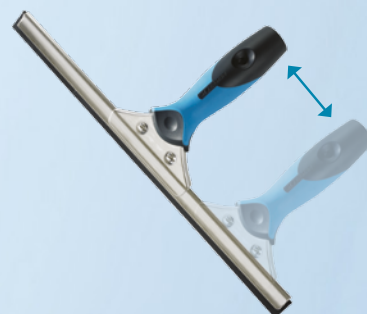

17733 **10 pcs/box**

BRASS HANDLE



2 screws to fix the channel



- Fastens securely to locking cone on extension pole.
- Easy On – Easy Off



Ergonomic grip

17846 **10 pcs/box**

STAINLESS STEEL CHANNEL



Notched channel to securely hold rubber and channel in place

- Premium brushed stainless steel
- Durable
- Lightweight
- Rust-resistant
- Complete with Dura-Flex® rubber



	channel + SOFT rubber	channel + HARD rubber
25 cm/10"	17788	19656
30 cm/12"	17789	19845
35 cm/14"	17790	19658
45 cm/18"	17791	19657

Packaging 10 pcs/box

ALUMINIUM CHANNEL



Complete with Dura-Flex® Soft rubber

Lightweight > comfortable use

15 cm/6"	18639
25 cm/10"	19814
30 cm/12"	19815
35 cm/14"	19816
45 cm/18"	19817
55 cm/22"	17792

Packaging 10 pcs/box

BRASS CHANNEL

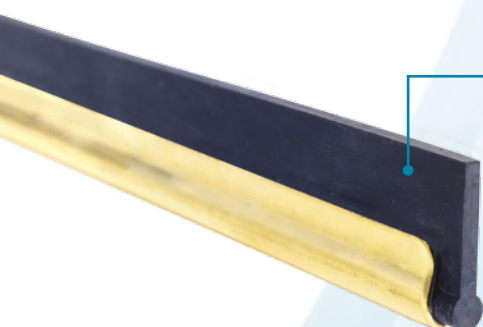

- Complete with Dura-Flex® Soft rubber
- The rubber blade is secured in the channel by 2 clips at each end.
- Clips = adjusting the tension of the rubber blade

25 cm/10"	17841
30 cm/12"	17842
35 cm/14"	17843
45 cm/18"	17844
55 cm/22"	17845

Packaging 10 pcs/box

DURA-FLEX® RUBBER

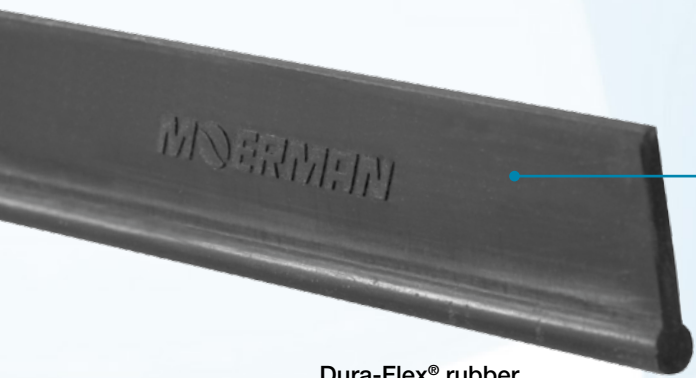

Dura-Flex® rubber



Premium quality rubber

- Perfect blend of rubber
- Precision cut for streak-free results
- Lasts longer



Liquidator Dura-Flex® rubber

Use in combination with Liquidator channel



- 50 shore (+/- 2)
- Ideal for colder temperatures
- Adjusts better to uneven surfaces



- 60 shore (+/-3)
- Ideal for warmer temperatures
- Ideal for smooth surfaces

Dura-Flex® rubber	SOFT	HARD
25 cm/10"	17782	19649
30 cm/12"	17783	19650
35 cm/14"	17784	19651
45 cm/18"	17785	19652
55 cm/22"	17786	19653
92 cm/36"	17787	19654
105 cm/42"	17894	19655

10 pcs/polybag - 10 polybags/box

Liquidator rubber	SOFT	HARD
25 cm/10"	21981	22285
30 cm/12"	22149	22286
35 cm/14"	21982	22287
45 cm/18"	21983	22288
55 cm/22"	22150	22289

10 pcs/polybag

PREMIUM T-BAR (BI-COMPONENT)



Multiple Cavities – Increased water retention

- Rigid design
- Anti-slip material
- Soft-touch
- Ergonomic
- Smooth surface
- Secure grip even when wet
- Fastens securely to locking cone on extension pole.
- Easy On – Easy Off



25 cm/10"	17780
35 cm/14"	17781
45 cm/18"	17840

Packaging 10 pcs/box

SWIVEL T-BAR



Swivels and locks in any position by turning the improved easy-grip wheel

- Ergonomic handle
- Fastens securely to locking cone on extension pole.
- Easy On – Easy Off

Multiple Cavities: Increased water retention



25 cm/10"	20630
35 cm/14"	20629
45 cm/18"	20631

Packaging 10 pcs/box



MONO T-BAR

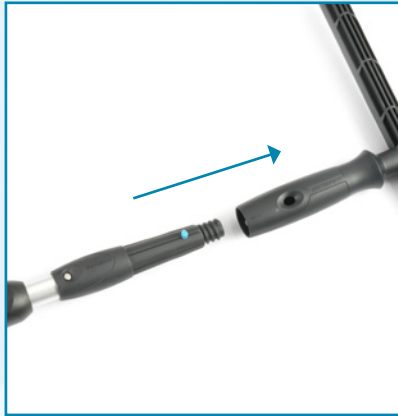
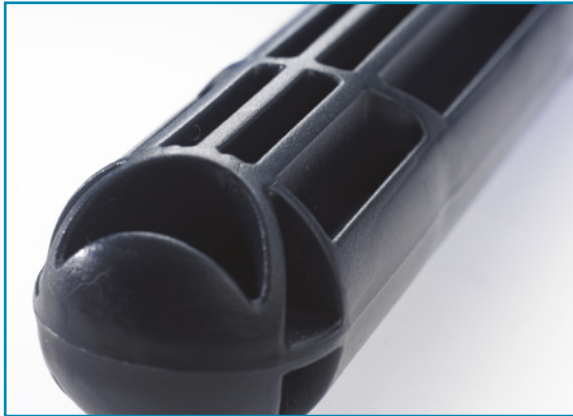

- Fastens securely to locking cone on extension pole.
- Easy On – Easy Off

Multiple Cavities – Increased water retention



- Ergonomic handle
- Lightweight
- Strong 1 piece design

15 cm/6"	18617
25 cm/10"	17777
35 cm/14"	17778
45 cm/18"	17779

Packaging 10 pcs/box

CLICK & SCRUB PAD



Scrub pad to remove tough dirt

Clicks onto the T-bars

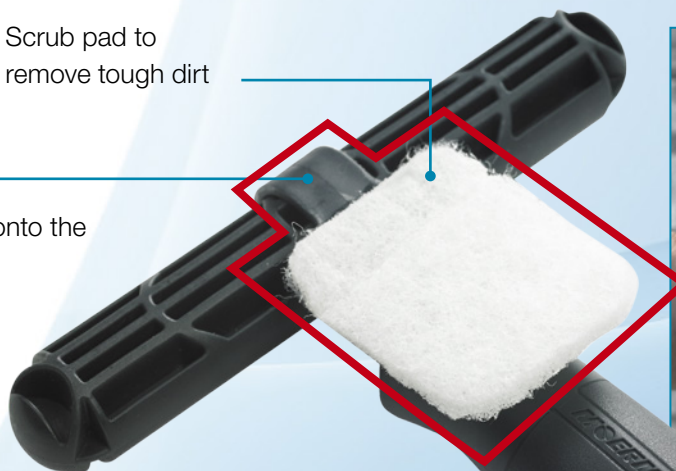

18927	10 pcs/polybag
-------	----------------

MOERMAN SLEEVES

PREMIUM SLEEVE

SILVER SLEEVE

STANDARD SLEEVE

SCRUBBING PAD SLEEVE

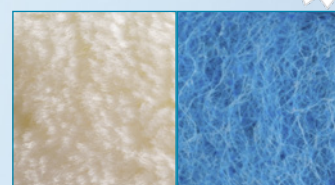
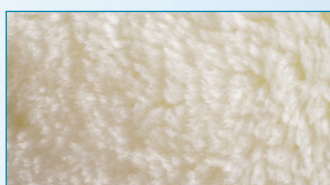
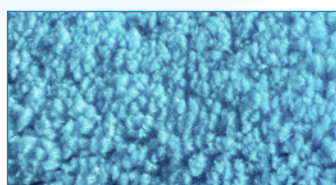
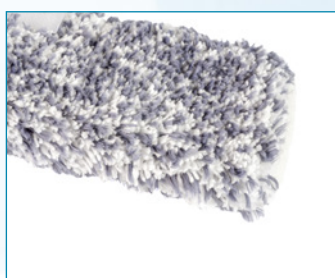

	PREMIUM SLEEVE	SILVER SLEEVE	STANDARD SLEEVE	SCRUBBING PAD SLEEVE
Cleaning power	superior	excellent	standard	standard + dirt remover
Color	turquoise	grey/white	white	white + blue scrub
Material plush face	100% polyester MICROFIBER	100% polyester MICROFIBER	80% acrylic 20% polyester	80% acrylic 20% polyester
Material backing	70% PES, 30% Hot Melt	100% polyester	100% polyester	100% polyester
Fiber length	16 mm (±)	12 mm (±)	17 mm (±)	17 mm (±)
Weight	1045 g/m ²	820 g/m ²	1050 g/m ²	1050 g/m ²
Scrub pad	yes	yes	no	yes
Fastener	velcro	velcro	velcro	velcro
Loops inside	yes for 45 cm	no	no	no
Available sizes	25/35/45 cm	25/35/45 cm	15/25/35/45 cm	25/35/45 cm
Maschine washable	60°C	60°C	60°C	60°C

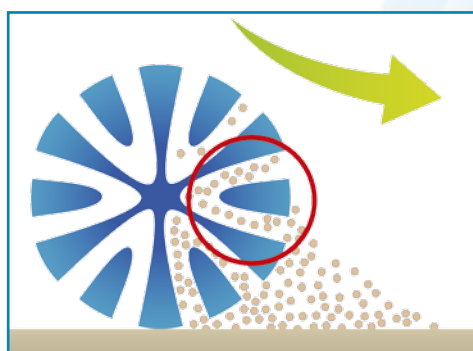

MICROFIBER: PREMIUM & SILVER SLEEVE

In our microfiber sleeves, the fiber is split during the manufacturing process to produce multi-stranded fibres.

The split fibres and the size of the individual filaments working in conjunction with the spaces between them makes the cloths more effective than other fabrics for cleaning purposes.

The structure traps and retains the dirt perfectly and also absorbs liquids.

PREMIUM SLEEVE



- Premium Microfiber sleeve
- Preferred by professionals
- Superior cleaning power
- High water retention
- Machine washable
- Lint free
- Excellent dirt pick-up
- Scubbing pad - Extra cleaning power

25 cm/10"	17760
35 cm/14"	17762
45 cm/18"	17762

Packaging 10 pcs/bag

SILVER SLEEVE

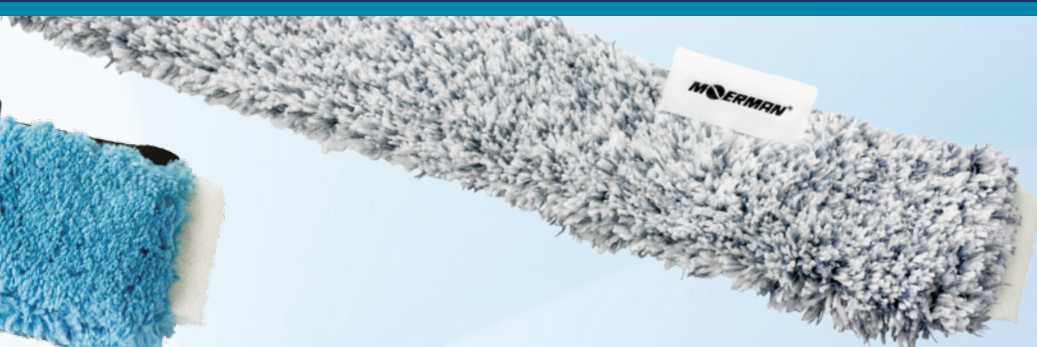

- Microfiber sleeve
- Perfect cleaning power
- Good water retention
- Machine washable
- Lint free
- Good dirt pick-up
- Scubbing pad - Extra cleaning power

25 cm/10"	20343
35 cm/14"	20344
45 cm/18"	20345

Packaging 10 pcs/bag

SCRUBBING PAD SLEEVE



- The rough blue textured abrasive cleaning pad removes dirt on the window
- Tough & durable
- Good cleaning power
- Machine washable



25 cm/10"	21514
35 cm/14"	21515
45 cm/18"	21516

Packaging 10 pcs/bag

STANDARD SLEEVE



- Tough & durable
- Good cleaning power
- Machine washable

15 cm/6"	18630
25 cm/10"	17701
35 cm/14"	17702
45 cm/18"	17703

Packaging 10 pcs/bag

EXTENSION POLE

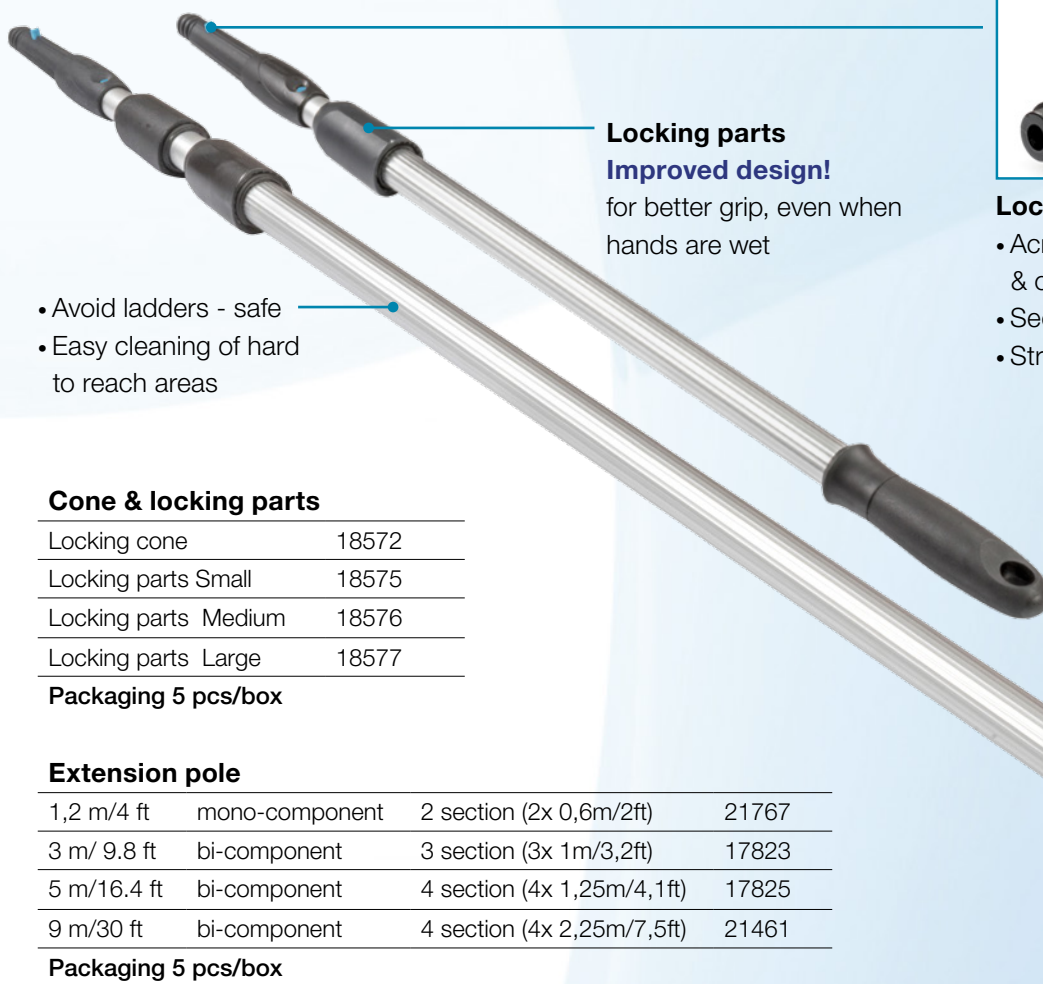

- Avoid ladders - safe
- Easy cleaning of hard to reach areas

Locking parts
Improved design!
 for better grip, even when hands are wet



Locking cone with acme tip

- Acme thread for paint rollers & other acme threaded accessories
- Secure locking mechanism
- Strong and lightweight

Bi-component handle

- Anti-slip material
- Soft-touch
- Ergonomic
- Smooth surface
- Secure grip, even when wet

Cone & locking parts

Locking cone	18572
Locking parts Small	18575
Locking parts Medium	18576
Locking parts Large	18577

Packaging 5 pcs/box

Extension pole

1,2 m/4 ft	mono-component	2 section (2x 0,6m/2ft)	21767
3 m/ 9.8 ft	bi-component	3 section (3x 1m/3,2ft)	17823
5 m/16.4 ft	bi-component	4 section (4x 1,25m/4,1ft)	17825
9 m/30 ft	bi-component	4 section (4x 2,25m/7,5ft)	21461

Packaging 5 pcs/box

ANGLE ADAPTER



1. Remove cone from extension pole

2. Place angle adapter directly on extension pole

3. Place ProClean tool on the angle adapter with the click-system

- Fits perfectly on the telescopic handle = easy cleaning of hard to reach places
- Strong and lightweight
- ProClean tools can securely be placed on the cone with the click-system. Easy On - Easy Off

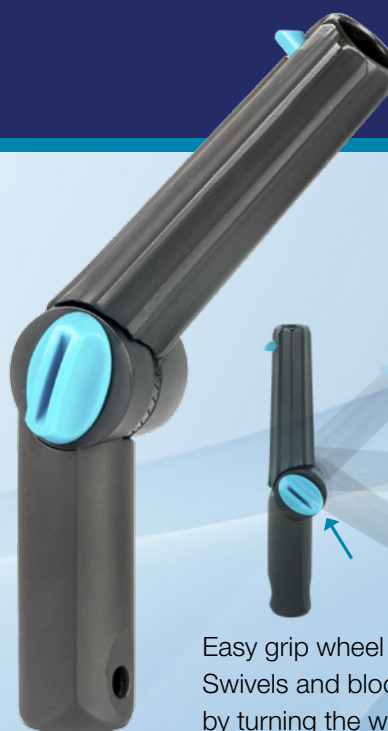

Easy grip wheel
 Swivels and blocks in any position by turning the wheel

22302 **5 pcs/box**

TOOL HOLDER & BELT



- Solid belt for carrying tools
- Tools always at hand
- Quickly fastens and unfastens via safety easy release
- Extra loops
- Tough nylon – durable
- Clip lock for quick fastening

- Holder for 2 squeegees and 1 washer
- Accepts all brands (up to 45 cm/18")
- Strong
- Durable
- Impact-resistant
- Left/right handed
- Ideal on ladders or for interior work
- **User-Friendly**



- Limited swivel-stop
- Tools can not fall out
- Reinforced ring - Lasts longer



- Reinforced bottom
- strong & durable

Tool holder

17833 **5 pcs/box**

Belt

17834 **5 pcs/box**

PROFI POUCH

- Strong nylon pouch
- Size: 32 cm/12.6" x 29 cm/11.4"
- 3 compartments
- Special compartment for holding a can
- Dry and wet cloths can be stored separately
- Front pocket with flap and velcro fastener



19765 **5 pcs/box**

GLOVES

- Neoprene gloves
- Cold protection
- Waterproof
- With hook & loop fastener



Small 17847

Large 17848

Extra large 17849

10 pcs/box

PREMIUM SCRAPER



Simple blade change
No tools required

Fits the Moerman professional telescopic handles for safe high-reach pole work



10 cm/4" wide scraping surface

Easy to use
no cap required

- Bi-component handle
- Anti-slip material
 - Soft-touch
 - Ergonomic
 - Smooth surface
 - Secure grip, even when wet

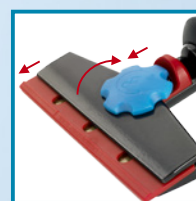

Safe



Ready to use

Premium scraper	17832
Premium scraper with handle 30 cm/11.8"	19257
Premium scraper with handle 120 cm/47.2"	19258
Packaging 10 pcs/box	



SCRAPERS

Pocket scraper

The pocket scraper removes stickers, tape, paint and stubborn dirt quickly from the window



Easy release makes changing blades easy

- Special safety locking mechanism
- Ergonomic rubber cover
- Convenient size
- Always on the spot

17706 **20 pcs/box**
blades not included

Squeegee handle scraper

Glass scraper in stainless steel holder



17829 **20 pcs/box**

REPLACEMENT BLADES

For Premium scraper & Squeegee handle scraper



- 10 cm/4" **double edge** blade for twice the wear
- Made of sharp, coated carbon steel
- Handy dispenser pack
- 25 blades per dispenser

17751 **10 dispensers/box**

For Premium scraper



- 10 cm/4" **single edge** blade
- Made of sharp, coated carbon steel
- Each blade packed in paraffin paper
- 25 blades per pack

17752 **8 packs/box**

For Pocket scraper

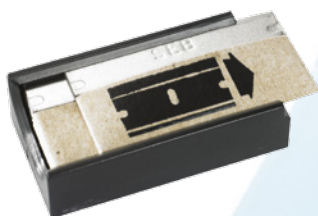

- 4 cm/1.5" single edge blades
- 5 blades per dispenser

17707 **20 dispensers/box**

WEB DUSTER

- Easy to clean by rubbing or rinsing with water
- 100% goat hair - the best for removing dust and dirt



Fastens securely to locking cone on extension pole



Firm plastic handgrip

21909 **4 pcs/box**

PIPE DUSTER

- Easy to clean by rubbing or rinsing with water
- 100% goat hair - the best for removing dust and dirt



Fastens securely to locking cone on extension pole



Firm plastic handgrip

21910 **4 pcs/box**

BUCKETS & ACCESSORIES

BUCKETS

- Heavy duty plastic buckets, suitable for a variety of cleaning jobs
- Accomodates 45 cm/18" t-bars/washers and squeegees
- Volume indication lines
- Strong plastic, ergonomic handle



Profi bucket

22 L / 6 gallons 19171 **5 pcs/box**



Maxi bucket

24 L / 6,5 gallons 19766 **6 pcs/box**



Double tool holder

17836 **10 set/bag**



Holds squeegee & 2 washers



Casters

17837 **4 casters/bag**

DETAILING CLOTH



- Microfiber
- Dimensions: 38 cm/15" x 40 cm/15.7"
- High absorption
3 times its own weight and more
- Professional quality
- Long lasting.
- Endures up to 500 wash cycles
- Perfect for detailing of windows

22235 **10 pcs/polybag**

CHAMMY



- Genuine chamois leather
- 100% natural product
- Size XXXL - 6 Ft²
- 100 % New Zealand Sheepskin
- 100 % fish oil tanned, no metal salts - no formaldehyde
- High absorption
5 times its own weight and more
- Professional quality
- Long lasting.

12551 **6 pcs/box**